



DEKO MG

Preassembled Double Glazed Modules







DEKO MG – Let the Light Shine Through

DEKO MG double glazed modules can transform traditional system partitions filling work spaces with brightness, adding interest and interaction.

DEKO MG modules are high quality, 100% dust free, pre-assembled modules which are ready for installation immediately they arrive on site. Compatible with both DEKO PV and DEKO PF they are based on the same post construction and can be fitted without the need for any site based modifications.

DEKO MG modules are completely reusable and can be incorporated as single modules or be used to form continuous glazed walls. If DEKO MG is not part of the initial construction phase the modules can be fitted at a later stage with minimal disruption.



The Module Construction

DEKO MG is preassembled and is constructed with two layers of 5 mm float or toughened glass fitted within an aluminium profile. The frame construction and the large gap between the two layers of glass provide a high sound reduction.

Standard modules are produced in natural anodised or white powder coated aluminium frames in the following sizes: 9 x 10 M, 9 x 12 M, and 9 x 21 M. Other frame sizes and colours are available on request.

DEKO MG has been designed to accommodate straight runs and 90° corners.

A maximum glass surface of 2.5 sqm is permitted in keeping with safety regulations.



Built-in or Build Together

DEKO MG has been developed to enhance DEKO PV and DEKO PF system partitions type 1090 or 1290.

Using the same post construction for glass, gypsum, and doors DEKO MG ensures a simpler and quicker construction phase compared to traditional builds.

Modules can be installed continuously to achieve the same attractive appearance as the DEKO GV double glazed partition with its minimal detailing.

DEKO MG is fully compatible with DEKO Doors. The unique aluminium frame which offers high stability levels will accept solid, glazed and fully glazed doors.

Aluminium architraves are also available and can be installed against solid modules if required.

Sound Reduction

A high sound reduction up to 48 dB is provided due to the large gap between the two panes of glass, but the achieved value of sound reduction depends on the percentage of glazed modules of the total partition area and type of partition.



Privacy

The design of DEKO MG gives various options for privacy.

DEKO MG can be supplied with built-in fine line venetian blinds fitted within the dust free area between the panes of glass.

The blinds can be operated manually with a revolving wand or with a small thumb knob. The blinds are easily maintained and have a long service life.

Alternatively, applied film can be fitted directly on to the glass panes. Stripes, patterns, or text can be accommodated. Film can be applied when the modules are being manufactured, fitted or at a later stage.

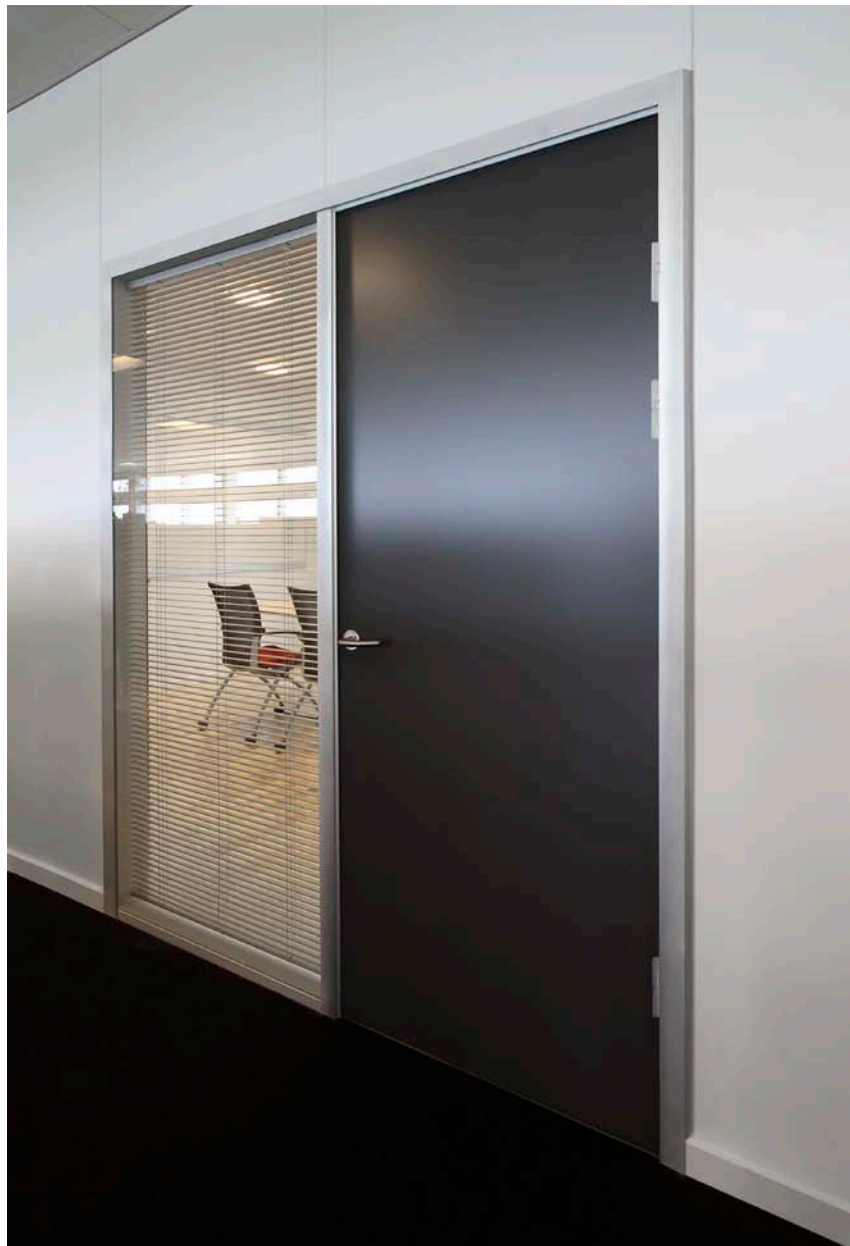
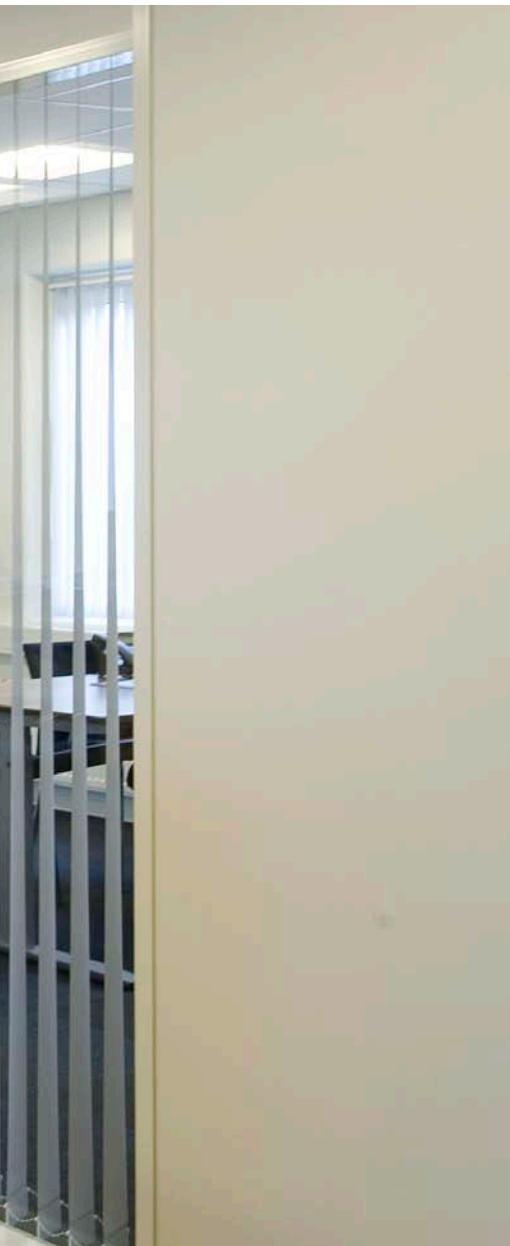

Details for DEKO MG

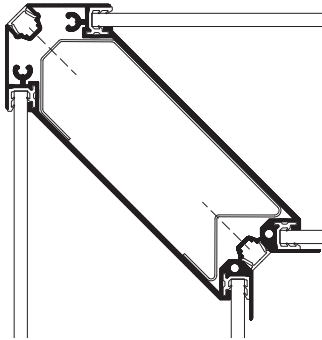

90° corner

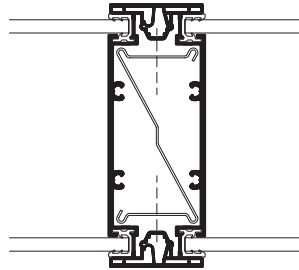

Glass joint
horizontal section

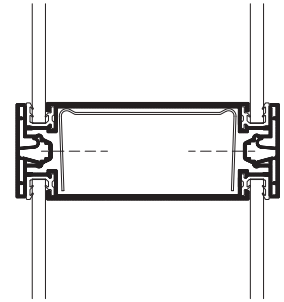

Glass joint
vertical section

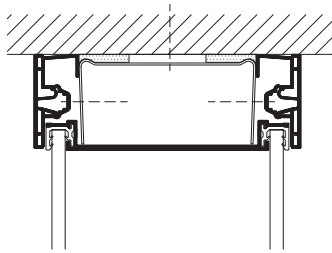

Ceiling connection

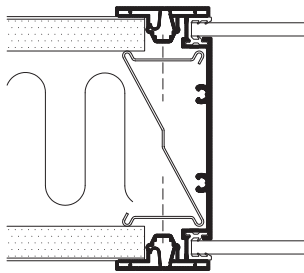

Gypsum board/glass joint
horizontal section

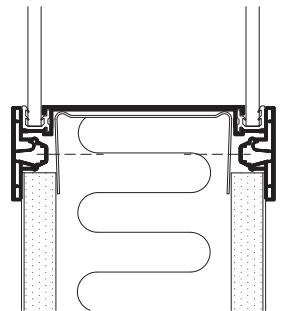

Gypsum board/glass joint
vertical section

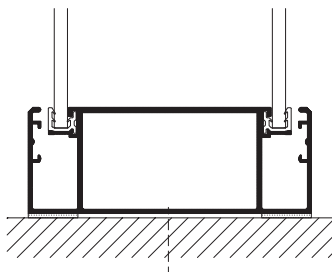

Floor connection



Type Summary

Type	Partition Thickness (mm)	Layers of Glass	Glass Thickness and Type (mm)	Weight (kg/sqm)	Airborne Sound Insulation (Rw)	Fire Resistance
MG 1090	92	2	5 + 5 mm	25	*	Unclassified
MG 1290	118	2	5 + 5 mm	25	*	Unclassified

*) The sound reduction achieved by the partition depends on the percentage of the glazed modules of the total partition area. Please contact DEKO or your local distributor for specific sound insulation values.

For updated type values go to www.deko.com



DEKO partitions ltd of denmark was established in 1970 and presently has approximately 300 employees. DEKO is the leading producer of demountable, glazed, and folding partitions in Scandinavia and distributes its product range to more than 35 countries worldwide including Europe, Africa, and Asia in co-operation with established local distributors.



DEKO partitions ltd of denmark
Maarkaervej 11
DK-2630 Taastrup - Denmark

Tel: +45 43 55 77 11
Fax: +45 43 55 77 13